

CDC-RF6

6-Disc FM Modulator CD Changer
For Use With Any FM Vehicle Radio

Changeur de CD/modulateur FM à 6 disques

Cambiador de Discos Compactos Para 6
Discos y Modulador de FM Para Uso con
Cualquier Radio FM de Vehículo

Cambiador CD para 6 discos com Modulador
FM para uso com qualquer Rádio FM de
Automóvel

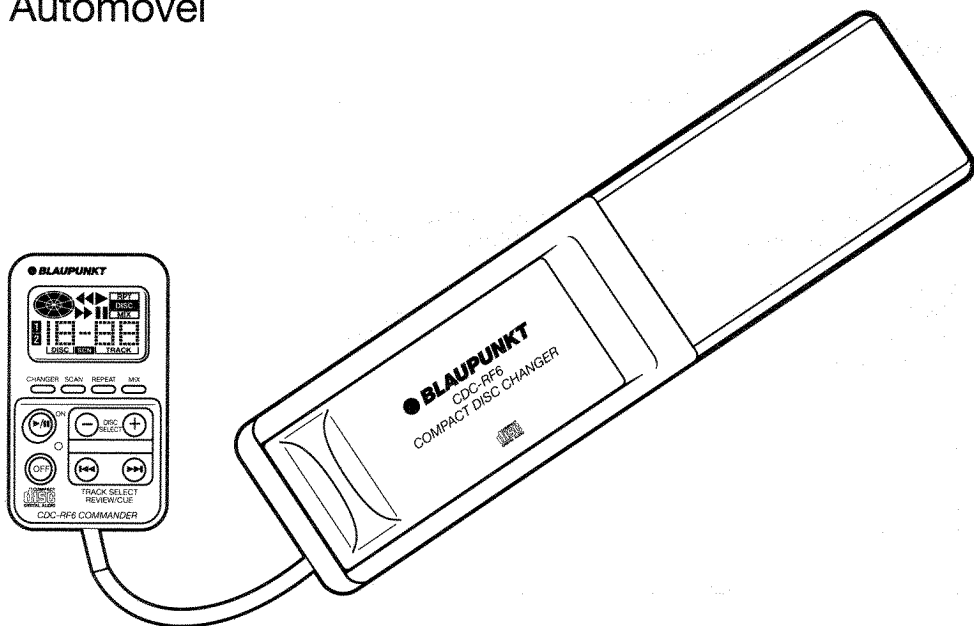

BLAUPUNKT
Bosch Group

Owner's Record

The model and warranty numbers are located on the rear of the unit. Record the warranty in the space provided below. Refer to these numbers whenever you call upon your Blaupunkt dealer regarding this product.

Model No. CDC-RF6

Warranty Number _____

FCC Warning

The equipment has been tested and found to comply with the limits for a Class B device, pursuant to Part 15 of the FCC Rules. These limits are designed to provide reasonable protection against harmful interference in a residential installation. This equipment generates, uses, and can radiate radio frequency energy, and, if not installed and used in accordance with instructions, may cause harmful interference with radio communications. However, there is no guarantee that radio interference will not occur in particular installation.

- The shielded interface cable recommended in this manual must be used with this equipment in order to comply with limits for a digital device pursuant to Sub-part B of Part 15 of the FCC rules.
- Because the laser beam used in this compact disc changer is harmful to the eyes, do not attempt to disassemble the cabinet. Refer servicing to qualified personnel only.
- You are cautioned that any changes or modifications not expressly approved in this manual could void your warranty and authority to operate this equipment.
- If you have any questions or problems concerning your unit that are not covered in this manual, please contact your Blaupunkt dealer.

CAUTION

The use of optical instruments with this product will increase eye hazard.

Because the laser beam used in this compact disc changer is harmful to the eyes, do not attempt to disassemble the cabinet. Refer servicing to qualified personnel only.

Safety Certification

This Compact Disc Player is made and tested to meet exacting safety standards. It meets FCC requirements and complies with safety performance standards of the U.S. Department of Health and Human Services.

Staple Your Sales Receipt Here

Table of Contents

Before installing and operating this unit, please read this manual thoroughly and retain it for future reference.

English

Owners's Record	2
FCC Warning.....	2
Features	4
Precautions	4
Before Installing and Testing The System	4
Electrical Connections	6
Installation	7
Specifications	12
Magazine & Compact Discs	13
Location of Controls	14
Operation Instructions	15
Switching to a Second Changer	16
Switching to Radio Or Tape	16
Troubleshooting Guide	17
Error Codes.....	18

Features

Congratulations on your purchase of your Blaupunkt CDC-RF6 FM Modulator CD Changer. This unit is designed to convert CD sound into FM signals (89.1 MHz or 88.7 MHz) and play them through any FM car stereo. This unit features:

- For Use With Any Electronically-Tuned FM Vehicle Radio
- Includes:
 - Changer
 - Wired Remote Control
 - FM Modulator
 - Disc Magazine
 - Cables
 - Mounting Hardware
- Features Include:
 - Disc and Track Select and Scan
 - Disc and Track Mix and Repeat
- Audible Cue/Review
- Pause/Play
- Switchable Output Frequency: 89.1 MHz/88.7 MHz
- Anti-Shock & Vibration Mechanism
- Power Requirement:
 - 12 V DC Vehicle Battery
- Compact, Space-Saving Dimensions:
 - 250 x 64 x 178 mm
 - 9 7/8 x 2 1/2 x 7 in. (W x H x D)
 - Fits in Many Gloveboxes
 - Vertical, Horizontal, or 45° Installation

Precautions

- The use of optical instruments with this product will increase eye hazard.
- Because the laser beam used in this compact disc changer is harmful to the eyes, do not attempt to disassemble the cabinet. Refer servicing to qualified personnel only.
- This CD Changer is designed to be operated only on +12 volt DC negative ground systems. The unit cannot be used on +24 volt or positive ground systems.
- If your vehicle was parked in direct sunlight resulting in a considerable rise in temperature inside the vehicle, allow the unit to cool off before operating your unit. The unit may not operate correctly in extremely hot or cold temperatures. The unit is equipped with a built in self protection circuit. When the temperature reaches a preset level, the protection circuit halts all unit operation. If this should happen, open a window and allow the car to cool.
- You are cautioned that any changes or modifications not expressly approved in this manual could void your warranty.
- If you have any questions or problems concerning your unit that are not covered in this manual, please contact your Blaupunkt dealer.

Before Installing and Testing The System

⚠ To avoid the aggravation of costly mistakes and serious damage that could make you feel this way – please carefully follow all of the instructions. You'll be glad you did!

General Recommendations

- If you're not confident that you can install the unit correctly, have it installed by a qualified Blaupunkt installation technician.
- Design and specifications subject to change without notice.
- We recommend making all electrical connections and testing the system before installing the unit.

Before Installing and Testing (continued)

Transport Lock Screws

The mechanism in the CD changer is "locked" into place during shipment by three transport screws. Be sure to remove the screws prior to testing the system and installation.

To keep dust out of the unit, which could cause a malfunction, place the enclosed seals over the screw holes after the Transport Lock Screws have been removed.

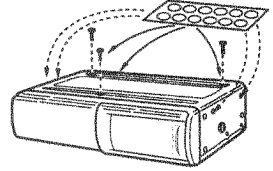

Reset Button

A Reset Button is located on the front panel of the Commander and must be activated with a pen tip or other thin object, as it is recessed to prevent accidental engagement. Press the Reset Button under the following circumstances:

1. After connections have been made for initial testing.
2. After installation, when all wiring is completed.
3. If abnormal disc operation is encountered, the Reset Button should be pressed to clear the system to return to normal operation.
4. After disconnecting and reconnecting the car battery, etc.

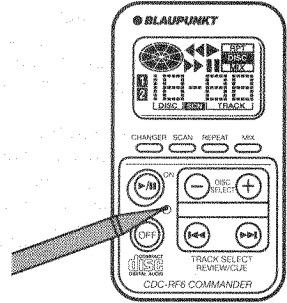

ID (Identity) Switch for 2nd CD Changer

To connect a second CDC-RF 6 changer, you must use Blaupunkt's CDC-RF BRIDGE, which is sold separately. When an additional CD changer has been connected using this unit, the ID switch is used to indicate the number of each respective changer unit.

- The ID switch is initially set to "1" when shipped.
- When only one changer is connected, the switch should be set to "1".
- When two changers are connected, one of the unit's switches should be set to "2" using a ballpoint pen or similar fine-tipped tool.

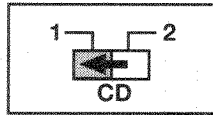
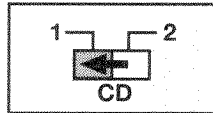
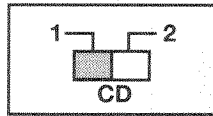

1st unit

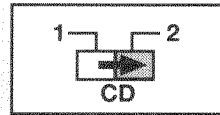
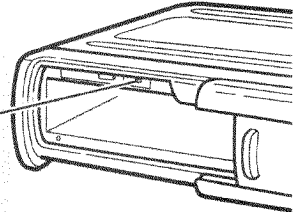

2nd unit (additional changer unit)

Setting the Radio Frequency

You must select and test the radio frequency that the changer will use before you mount the FM Modulator.

Set the radio frequency setting to 89.1 using the switch on the back of the FM Modulator. Test the operation of the changer. (See page 15) If a clear signal cannot be obtained on 89.1 MHz, change the position of the frequency-select switch to 88.7.

The radio sensitivity is slightly reduced when the FM Modulator is connected.

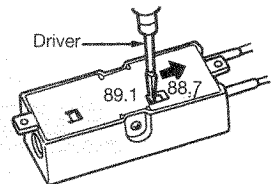

Electrical Connections

Electrical Connections

- Caution: before making connections, disconnect the ground wire terminal of the car battery to avoid short circuits.
- Use this unit only with negative ground 12 Volt (11- 16 Volt) direct current (DC).
- Be sure to use the supplied changer cord. Using a cord other than the one supplied may cause noise or damage.
- Be sure to connect the changer cord to the FM Modulator before mounting. If you attach the changer cord to the modulator and the cord projects down toward the back of the modulator, remove the cord and attach the other end of the cord to the modulator.

Power Connections - To prevent short circuits and/or serious damage:

- Disconnect the vehicle battery's negative terminal before making connections.
Note - If the changer is to be installed in a car that is equipped with an on-board drive or navigation computer, do not disconnect the battery cable. If the cable is disconnected, the computer memory may be lost. Under these conditions, use extra caution to avoid causing a short circuit during installation.
- Connect leads according to the wiring diagram.
- Connect the yellow lead to a constant source of power which has passed through the vehicle's fuse unit.
- Connect the red power input lead only after the other leads are connected. And be sure to connect it to a positive (+) 12 Volt power terminal that is energized only when the ignition key is set to the accessory position or on position.
- Connect the black lead to a grounded metal part of the vehicle. We recommend grounding all audio system black ground leads (head unit, external amplifier, etc.) to a common point.

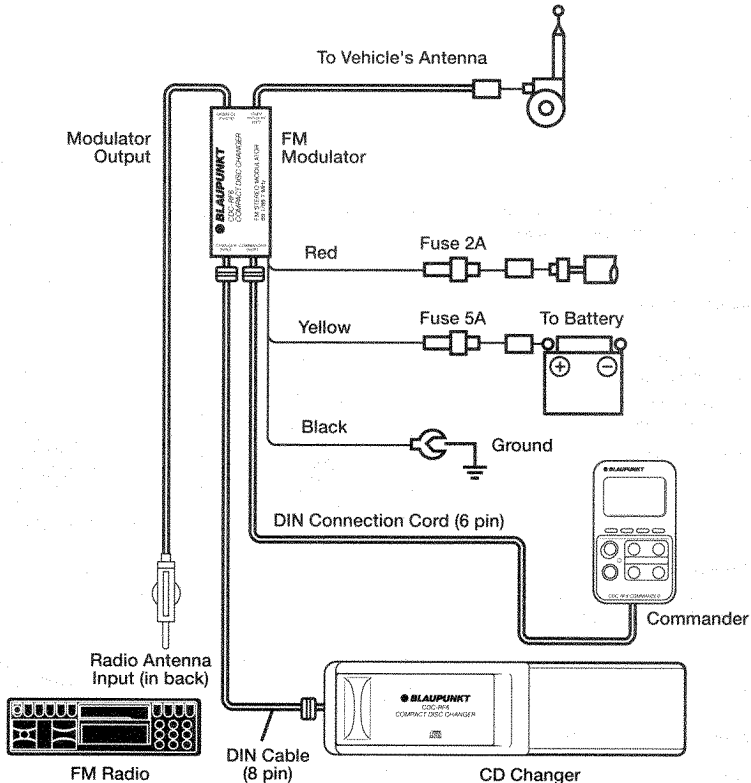

Installation

Recommendations

- Carefully choose the mounting location so that the unit won't interfere with normal driving.
- Avoid installing the unit in a place:
 - Subject to temperatures exceeding 55 degrees C (131 degrees F) (such as in a car parked in direct sunlight.)
 - Subject to direct sunlight
 - Subject to excessive vibration
 - Near heat sources (such as heaters and heat ducts)
 - Exposed to rain, moisture, excessive dirt and/or dust
- This unit should not be installed in any way except that which is authorized (on its side, on its end, at a 45° angle or suspended). Installing it with its side facing down or upside down can cause malfunctioning.
- The fuel tank must not be damaged by the installation.
- The unit should not cover any wires or pipelines.
- The unit (and its installation) should not damage or interfere with access to the spare tire, tools or other equipment in or under the trunk.
- For a safe and secure installation, be sure to use only the supplied mounting hardware.
- Press the reset button after completing the electrical connections and installation. The reset button is located on the front of the Commander (See page 5).
- If you have any questions or problems concerning your unit that are not covered in this manual, please contact your Blaupunkt dealer.
- Be sure to remove the transport screws (See page 5).

Anti-Vibration Setting

- This unit can be installed horizontally (to the floor or suspended), vertically, and at a 45° angle.
- Once the installation position has been chosen, set Anti-Vibration Setting Switches on both sides of the unit using a screwdriver.
- The unit may skip if used with the wrong installation setting.

Type of Installation	Setting
Horizontal	H
Suspended	H
Vertical	V
45° angle	45°

Mounting Hardware

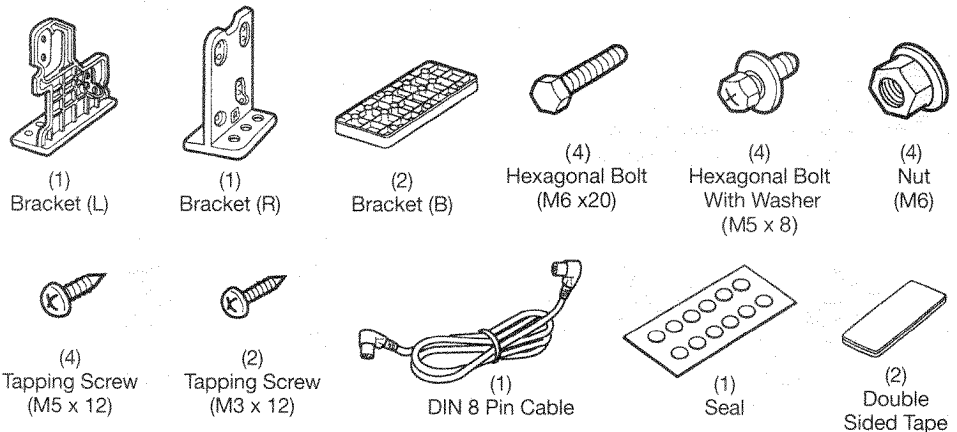

Horizontal Installation

1

- Confirm that Anti-Vibration Switches on both left and right sides are set to position H.
- Attach bracket (L) and bracket (R) using the hexagonal bolts (M5 x 8).
- Attach brackets (L) and (R) to their respective brackets (B) using the hexagonal bolts (M6 x 20) and the hexagonal nuts (M6).

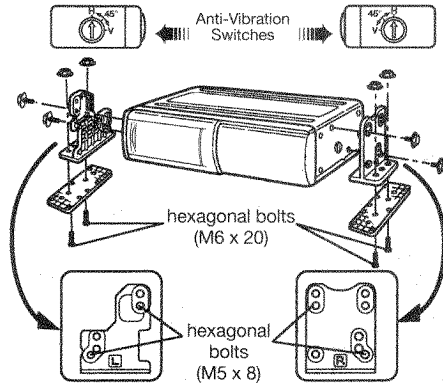

2

- Pull back the carpet and determine where to attach the unit.
- Stick the supplied double-sided tape to the bottom of the brackets (B) and peel off the paper backing.
- Affix the unit to the floor by pressing in place.

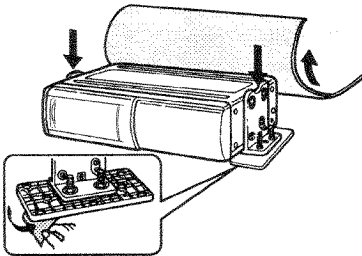

3

- Remove the hexagonal nuts and take off the changer.

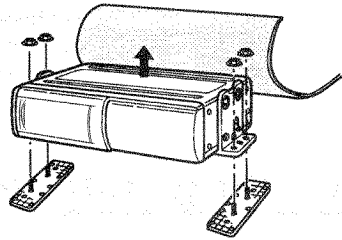

4

- Using a knife, cut "X"s in the carpet directly above the brackets (B) bolts.
- Return the carpet to its original position allowing the bolts to protrude through.

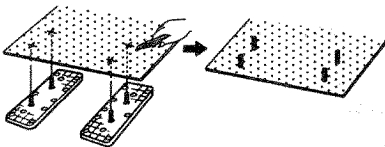

5

- Once more, use the hexagonal nuts to attach the changer on top of the carpet.

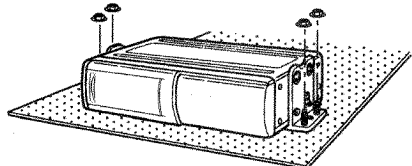

Vertical Installation

1

- Confirm that Anti-Vibration Switches on both left and right sides are set to position V.
- Attach brackets (L) and (R) using the hexagonal bolts (M5 x 8).
- Attach brackets (L) and (R) to their respective brackets (B) using the hexagonal bolts (M6 x 20) and the hexagonal nuts (M6).

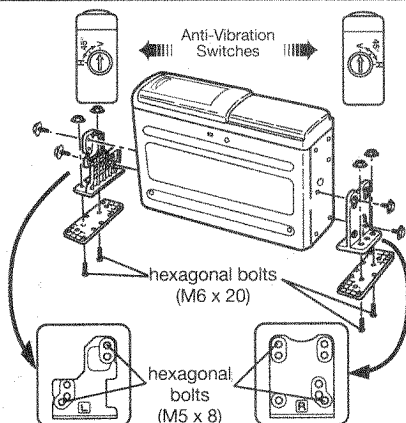

2

- Pull back the carpet and determine where to attach the unit.
- Stick the supplied double-sided tape to the bottom of the brackets (B) and peel off the paper backing.
- Affix the unit to the floor by pressing in place.

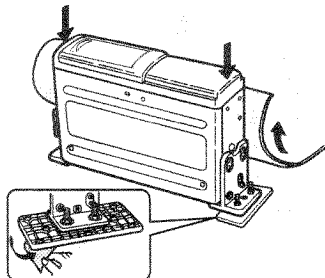

3

- Remove the hexagonal nuts and take off the changer.

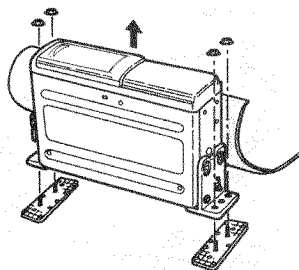

4

- Using a knife, cut "X"s in the carpet directly above the brackets (B) bolts.
- Return the carpet to its original position allowing the bolts to protrude through.

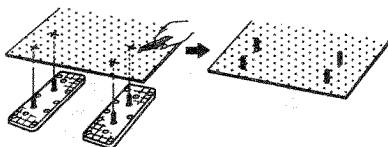

5

- Once more, use the hexagonal nuts to attach the changer on top of the carpet.

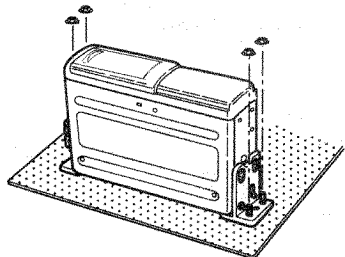

45° Installation

1

- Confirm that Anti-Vibration Switches on both left and right sides are set to position 45°.
- Attach brackets (L) and (R) using the hexagonal bolts (M5 x 8).
- Attach brackets (L) and (R) to their respective brackets (B) using the hexagonal bolts (M6 x 20) and the hexagonal nuts (M6).

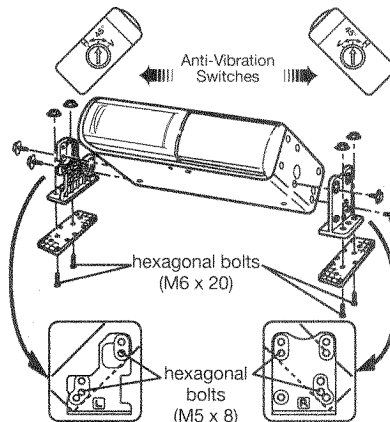

2

- Pull back the carpet and determine where to attach the unit.
- Stick the supplied double-sided tape to the bottom of the brackets (B) and peel off the paper backing.
- Affix the unit to the floor by pressing in place.

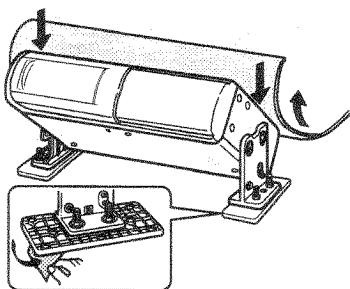

3

- Remove the hexagonal nuts and take off the changer.

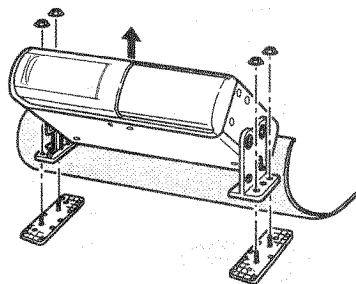

4

- Using a knife, cut "X"s in the carpet directly above the brackets (B) bolts.
- Return the carpet to its original position allowing the bolts to protrude through.

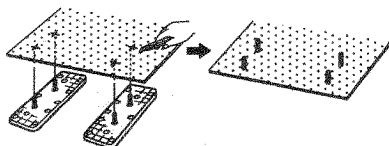

5

- Once more, use the hexagonal nuts to attach the changer on top of the carpet.

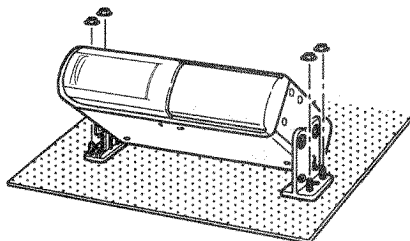

Suspended Installation

1

- Make sure that the unit does not hinder the movement of torsion bar spring or other parts of the trunk lid.
- Confirm Anti-Vibration Switches on both the left and right sides are set to position "H".
- Attach bracket (L) and bracket (R) using the hexagonal bolts (M5 x 8).

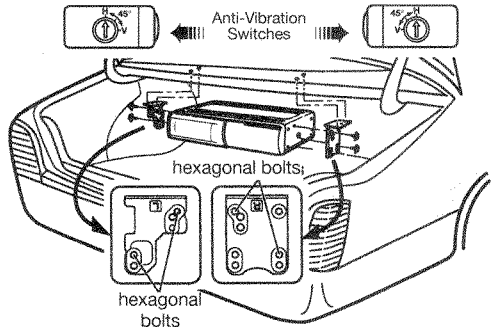

2

- Determine the mounting location and drill four mounting holes.

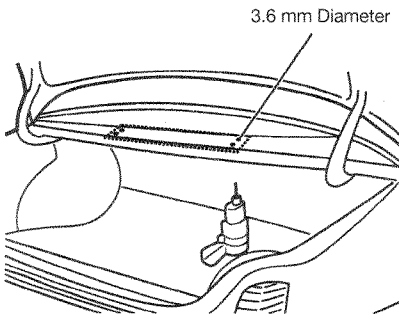

3

- Attach the CD changer with the tapping screws (M5 x 12).

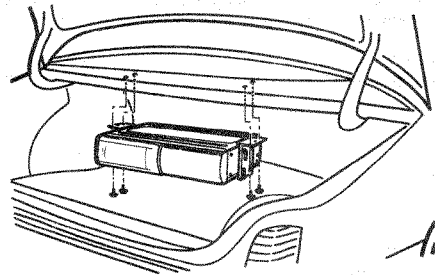

Installation of the Controller

Peel off the removable seal on the back of the controller unit and install it in a location that will not obstruct driving.

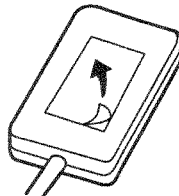

Installation of the FM Modulator

Install the FM Modulator to the floor or other surface with the included tapping screws (M3x12).

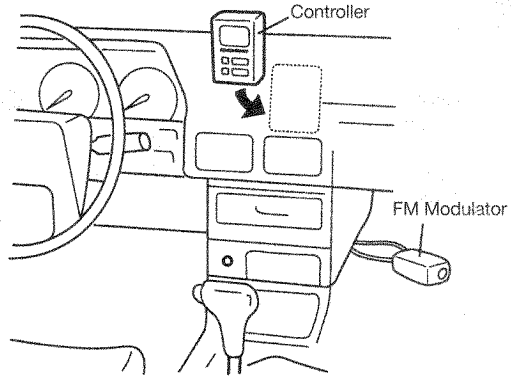
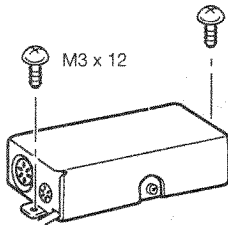

Changer Specifications

System	Compact disc digital audio system
Oversampling	1-Bit/8 X Oversampling
Laser Diode	GaALAs Double Hetero Type
Frequency response	20-15,000 Hz +/- 3 dB
Wow and Flutter	Below Measurable limit
THD (Total Harmonic Distortion)	0.1%
Dynamic Range	95 dB
Signal-to-Noise Ratio	90 dB
Channel Separation	75 dB
Current Drain	0.4 A (During playback) 1.0 A (During loading or ejecting a disc)
Operating Temperature	- 10° to 50° C / 14° to 122° F
Dimensions	250 x 64 x 178 mm 9 7/8 x 2 1/2 x 7 in. (W x H x D)
Mass	Approximately 2.0 kg/4.4 lbs.
Power Requirement	12 V DC Vehicle Battery (Negative Ground)
Part Number	9 404 230 296

Magazine & Compact Discs

Notes on the Disc Magazine

Dirt, dust, scratches and warpage cause sound skips during playback and a deterioration of sound quality. Here are some suggestions on how to take care of your discs and the magazine:

- Use compact discs that have the mark compact disc logo.



- Do not use 3" (8cm) discs with the CDC-RF6.
- Handle the disc by its edge, and to keep the disc clean, do not touch the surface.
- Do not leave the discs or the magazine in locations with high temperatures and high humidity, such as on a car dashboard or at the rear window where they will be subjected to direct sunlight or near heat ducts.
- Do not stick paper or write anything on the disc surface.
- Do not drop the disc magazine or subject it to a violent shock.
- Do not insert more than one disc at a time into a slot, otherwise the changer and the discs may be damaged.
- Discs should be put back in their cases after use to avoid serious scratches that could cause the sound to skip.

Cleaning Discs

Before playing, remove fingerprints and dust the disc with a compact disc cleaning cloth. Wipe the disc from the center of the disc to the outer edge of the disc. Do not use solvents such as benzine, thinner, commercially available cleaners or anti-static spray intended for analog discs.

Wipe in a straight motion from the inside to the outside of the disc.

Although protective film is being marketed as a CD accessory, use of this type of product will result in malfunctions and should absolutely be avoided.

Loading A Disc

1. Grip the tab on the magazine's disc tray and pull out only one of the trays.
2. Each tray can accommodate only one disc.
 - Put the disc in the tray with its *play surface facing up and the printed (labeled) surface facing down*. "E-07" appears about 8 seconds if the disc is placed upside down.
 - Do not play 3" (8 cm) discs in this unit.
3. Press the tab on the disc tray to store the tray back in the magazine. Up to six discs can be loaded.

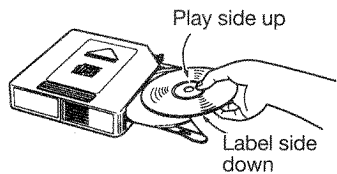
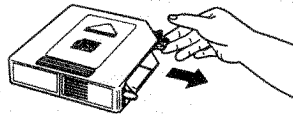

Magazine & Compact Discs

Installing The Magazine

1. Slide the door toward the right.
 2. Position the magazine so the top is facing up, and the arrow is facing the changer. Push it in until it clicks into place. Note: When the magazine is used for the first time, it will not lock into place unless the power supply has been connected.
- Make sure the door is closed. Otherwise, foreign matter may enter the unit, and contaminate the lenses inside the changer.
 - When the magazine has been inserted into changer (or when the Reset Button on the Commander is pressed), the unit will automatically be activated and begin reading the information on the CDs, one CD at a time, until all of the CDs have been read.

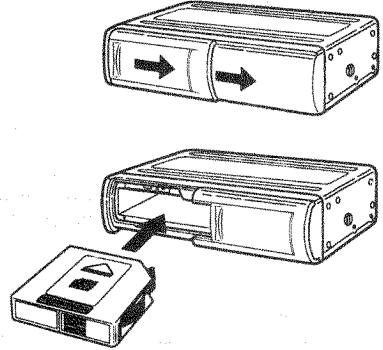

Ejecting The Magazine

Press the Eject Button inside the unit to remove the magazine. Note: Be sure to close the door after inserting or removing the magazine. If dust or dirt enters the changer, it may cause a malfunction.

Remove the magazine from the unit between uses during hot weather and when the CD changer is not used for long periods of time.

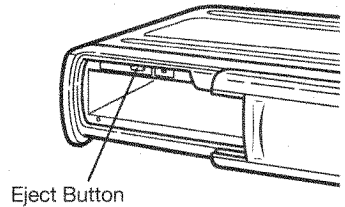

Location of Controls

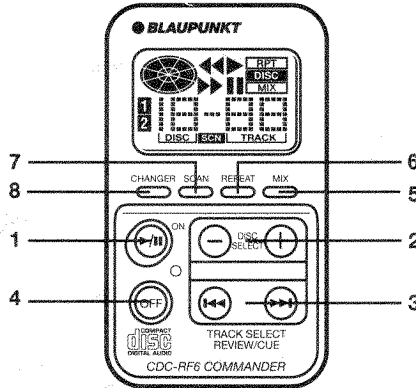

1. **Play/Pause Button** Press to turn unit on, to temporarily pause play or to resume play.
2. **DISC SELECT Button** Press to select the desired disc.
3. **TRACK SELECT Button** Press to select the desired track. Keep this button depressed during play for audible cue and review.
4. **OFF Button** Press to turn the unit off.
5. **MIX Button** This plays the tracks or discs in a random sequence.
6. **REPEAT Button** This plays a certain track or disc over and over again.
7. **SCAN Button** This plays the first portion of each track or disc.
8. **CHANGER Button** When two CD changers have been installed, use this button to select the changer whose CDs are to be played.

Operating Instructions

Before operating the unit for the first time (or after reconnecting the battery, etc.) press the Reset Button on the Commander. See page 5. Load the discs into the CD magazine and install the magazine into the CD charger.

Turning Unit On/Playing A CD

Vehicle ignition must be on. Turn on the car stereo and select FM band. Tune the radio to either 89.1 or 88.7 MHz. (depending on frequency chosen during installation). We suggest dedicating a Preset Radio Station Button to the frequency chosen during installation. To turn CD Changer on, press Play/Pause Button (1). The LCD panel on the controller will illuminate and show the Disc Number, the Track Number. Play of first disc will begin.

Pause

Press the Play/Pause Button (1) during play. II appears on the display and play is temporarily stopped. Press the button again to resume play starting from where it was stopped. When the pause mode is maintained for 5 minutes or more, the power will be automatically turned off.



Turning Unit Off

Press the OFF Button (4) to turn the unit off. The Commander's backlighting stays on.



At The End Of The Disc

When the last track on each disc is finished, the next available disc is automatically selected and play begins with the first track on the disc. When the last track on the last disc in the CD magazine is finished, the first disc is automatically selected and play begins with the first track on the disc.

Moving To Another Track

- To go to the next track, press and release the  Control (3).
- To go back to the beginning of the track being played, press and release the  Control (3).
- Press these controls repeatedly to locate previous or succeeding tracks.

Audible Cue/Review

- To move within a track, press and hold the  Control (3) for audible cue or the  control (3) for audible review.
- The display flashes, and play is skipped to the desired part of a track in the forward or backward direction.
- When the Track Select Button is kept depressed until the start or end of the disc is reached, the unit goes into a Pause mode.

Switching to Another Disc

Display the number of the disc to be heard using the Disc Select Button (2).

- To advance to the next disc, press the right side of the Disc Select Button.
- To return the previous disc, press the left side of the Disc Select Button.

Repeat

Track Repeat - Press the Repeat Button (6). RPT appears in the display, and the track now heard is played repeatedly.

Disc Repeat - When the Repeat Button (6) is pressed for two seconds or more, DISC and RPT appear, and the disc now heard is played repeatedly.

Press the Repeat Button again to end repeat play.

Continued on Next Page

Operating Instructions

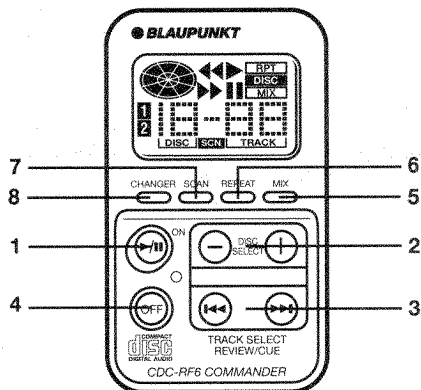

Mix Play

Track Mix - Press the MIX Button (5). MIX appears in the Display, and the tracks on the disc now heard are played in a random order. When all the tracks have been played, they will be played again, this time in a different random order.

Disc Mix - When the MIX Button (5) is pressed for two seconds or more, DISC and MIX appear, the sequence in which the discs are to be played is first re-arranged and then the sequence in which the tracks are to be played is rearranged, after which the tracks on the first disc are played. When all the tracks on the first disc have been played, operation advances to the next disc.

Press the MIX Button again to release the Mix Play function.

Track Scan

When the Scan Button (7) is pressed, SCAN appears, and the first 10 seconds of each track on the selected disc are played in order. To cancel, press it again.

Disc Scan

When the Scan Button (7) is pressed for two seconds or more DISC and SCN appears, and the first 10 seconds of each track on each disc are played in order. To cancel, press it again.

Switching To A Second CD Changer (If connected)

If the CDC-RF BRIDGE (sold separately) is used, this CD changer system can accommodate an additional CDC-RF6 Changer. When two CD changers have been installed, the Changer Select Button (8) is used to select the desired changer. This button is not operational when only one CD changer has been connected.

Switching To Radio Or Tape

Press the OFF Button (4) to stop CD play, and listen to the radio or tape. Noise is heard and the reception deteriorates when listening to the radio without stopping CD play first. To resume CD play, set the radio's FM frequency to 89.1 MHz or 88.7 MHz and press the Play/Pause Button (1).

Troubleshooting Guide

The following check will assist in the correction of most problems that you might encounter with your unit. Perform the checks described below before contacting your Blaupunkt dealer.

Symptom	Cause	Remedy
No Power	Fuse blown.	Replace with a fuse of the same type and rating as the original. If the fuse blows again, consult with your dealer.
	Improper connection.	Check connections.
No Sound	Improper connection.	Check connections.
No Sound, Two-speaker System	Fader set to non-existent speakers.	Set fader to center position to determine if speakers are wired for front or rear setting.
Magazine cannot be installed.	Attempt made to insert magazine improperly.	Insert it in proper direction.
Selected disc does not play.	Disc is loaded incorrectly.	Load disc with play side facing up. (Printed side should face down).
Noise is heard during playback or sound is intermittent.	Large scratches on disc or warped disc.	Compare sound with another disc. If sound from second disc is acceptable, first disc is defective.
	Extremely dirty disc.	Clean disc.
	Transit Screws still in place.	Remove 3 screws on bottom of unit and try again.
	Anti-Vibration Switch set in wrong position.	Set the Anti-Vibration Switch to the correct position (See page 7-11).

Fuse Replacement

When replacing the fuse, be sure to use one with the correct amperage, which will be stated on the fuse case. Never use a fuse that has a stated amperage exceeding the one supplied for this unit, as this could cause malfunction and serious damage to the unit.

Moisture Condensation

On a rainy day or in a very damp area, moisture may condense on the lens inside the unit. Should this occur, the unit will not operate properly. In this case, remove the disc and wait for about an hour until the moisture has evaporated.

Error Codes

If the changer malfunctions, one of the following error codes will be displayed:

Error Display	Cause	Remedy
<pre> 0000 0000 0000 0000 0000 0000 0000 0000 </pre>	Disc change malfunction.	Consult with dealer.
<pre> 0000 0000 0000 0000 0000 0000 0000 0000 0000 </pre>	Disc loaded with print facing up or disc is dirty.	Load disc properly. Clean disc.
<pre> 0000 0000 0000 0000 0000 0000 0000 0000 0000 </pre>	Temperature inside car too hot.	Allow the car to cool. Then press the Play/Pause Button.
<pre> 000 000 000 000 </pre>	Magazine has not been installed.	Install magazine.
<pre> 0000 0000 0000 0000 0000 0000 </pre>	No discs in magazine.	Load discs into magazine.
<pre> 0000 000 000 0000 000 000 </pre>	No discs in slot No 2.	Load discs into slot No 2.